

## Half Bridge IGBT Module

### 电气特性:

- 1700V 沟槽栅/场终止工艺
- 低开关损耗
- 正温度系数

### 典型应用:

- 变频器
- UPS
- 伺服
- 逆变器

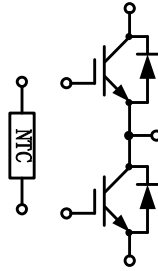

$V_{CES} = 1700V$ ,  $I_{C\ nom} = 450A$  /  $I_{CRM} = 900A$

## IGBT, 逆变器 / IGBT, Inverter

### 最大额定值 / Maximum Ratings

Parameter	Conditions	Symbol	Value	Unit
集电极-发射极电压 Collector-Emitter voltage	$T_{vj} = 25^{\circ}C$	$V_{CES}$	1700	V
连续集电极直流电流 Continuous DC collector current	$T_C = 100^{\circ}C$ , $T_{vj\ max} = 175^{\circ}C$	$I_{C\ nom}$	450	A
集电极重复峰值电流 Repetitive peak collector current	$t_p = 1\ ms$	$I_{CRM}$	900	A
总功率损耗 Total power dissipation	$T_C = 25^{\circ}C$ , $T_{vj\ max} = 175^{\circ}C$	$P_{tot}$	2500	W
栅极-发射极电压 Gate emitter voltage		$V_{GE}$	$\pm 20$	V

### 特征值 / Characteristic Values

Parameter	Conditions	Symbol	Value			Unit
			Min.	Typ.	Max.	
集电极-发射极饱和电压 Collector-Emitter saturation voltage	$V_{GE} = 15V$ , $I_C = 450A$ $T_{vj} = 25^{\circ}C$ $V_{GE} = 15V$ , $I_C = 450A$ $T_{vj} = 125^{\circ}C$ $V_{GE} = 15V$ , $I_C = 450A$ $T_{vj} = 150^{\circ}C$	$V_{CEsat}$		2.14 2.54 2.65	2.55	V
栅极-发射极阈值电压 Gate-Emitter threshold voltage	$I_C = 18mA$ , $V_{GE} = V_{CE}$ $T_{vj} = 25^{\circ}C$	$V_{GE(th)}$	4.90	5.50	6.10	
内部栅极电阻 Internal gate resistor		$R_{Gint}$		1.60		$\Omega$
输入电容 Input capacitance	$f = 1MHz$ , $V_{CE} = 25\ V$ , $V_{GE} = 0\ V$ $T_{vj} = 25^{\circ}C$	$C_{ies}$		44.00		nF

Input capacitance						
反向传输电容 Reverse transfer capacitance			$C_{res}$		1.30	
集电极-发射极截止电流 Collector-emitter cut-off current	$V_{CE}=1700V, V_{GE}=0V$	$T_{vj}=25^{\circ}C$	$I_{CES}$		2	mA
栅极-发射极漏电流 Gate-emitter leakage current	$V_{CE}=0V, V_{GE}=20V$	$T_{vj}=25^{\circ}C$	$I_{GES}$		200	nA
开通延迟时间 Turn-on delay time	$I_C=450A, V_{CE}=900V$ $V_{GE}=\pm 15V, R_G=3.3\Omega$ (电感负载) / (inductive load)	$T_{vj}=25^{\circ}C$ $T_{vj}=125^{\circ}C$ $T_{vj}=150^{\circ}C$	$t_{don}$		264 251 158	ns
上升时间 Rise time	$I_C=450A, V_{CE}=900V$ $V_{GE}=\pm 15V, R_G=3.3\Omega$ (电感负载) / (inductive load)	$T_{vj}=25^{\circ}C$ $T_{vj}=125^{\circ}C$ $T_{vj}=150^{\circ}C$	$t_r$		109 109 117	
关断延迟时间 Turn-off delay time	$I_C=450A, V_{CE}=900V$ $V_{GE}=\pm 15V, R_G=3.3\Omega$ (电感负载) / (inductive load)	$T_{vj}=25^{\circ}C$ $T_{vj}=125^{\circ}C$ $T_{vj}=150^{\circ}C$	$t_{doff}$		555 618 618	
下降时间 Fall time	$I_C=450A, V_{CE}=900V$ $V_{GE}=\pm 15V, R_G=3.3\Omega$ (电感负载) / (inductive load)	$T_{vj}=25^{\circ}C$ $T_{vj}=125^{\circ}C$ $T_{vj}=150^{\circ}C$	$t_f$		295 536 462	
开通损耗能量 (每脉冲) Turn-on energy loss per pulse	$I_C=450A, V_{CE}=900V$ $V_{GE}=\pm 15V, R_G=3.3\Omega$ (电感负载) / (inductive load)	$T_{vj}=25^{\circ}C$ $T_{vj}=125^{\circ}C$ $T_{vj}=150^{\circ}C$	$E_{on}$		117.7 137.3 161.0	mJ
关断损耗能量 (每脉冲) Turn-off energy loss per pulse	$I_C=450A, V_{CE}=900V$ $V_{GE}=\pm 15V, R_G=3.3\Omega$ (电感负载) / (inductive load)	$T_{vj}=25^{\circ}C$ $T_{vj}=125^{\circ}C$ $T_{vj}=150^{\circ}C$	$E_{off}$		89.53 119.2 119.1	
短路数据 SC data	$V_{GE}\leq 15V, V_{ce}=900V$ $V_{CEmax}=V_{CES}-L_{sCE}\cdot di/dt \quad t_p\leq 10\mu s, T_{vj}=150^{\circ}C$		$I_{SC}$		2053	A
结-外壳热阻 Thermal resistance, junction to case	每个 IGBT / per IGBT		$R_{thJC}$		0.06	K/W
在开关状态下温度 Temperature under switching conditions			$T_{vj op}$	-40	150	$^{\circ}C$

## 二极管, 逆变器 / Diode, Inverter

### 最大额定值 / Maximum Ratings

Parameter	Conditions	Symbol	Value	Unit
反向重复峰值电压 Repetitive peak reverse voltage	$T_{vj}=25^{\circ}C$	$V_{RRM}$	1700	V
连续正向直流电流 Continuous DC forward current		$I_F$	450	A
正向重复峰值电流 Repetitive peak forward current	$t_p=1ms$	$I_{FRM}$	900	A
$I^2t$ 值 $I^2t$ -value	$t_p=10ms, \sin 180^{\circ}, T_j=125^{\circ}C$	$I^2t$	20000	$A^2s$

### 特征值 / Characteristic Values

Parameter	Conditions	Symbol	Value			Unit
			Min.	Typ.	Max.	
正向电压 Forward voltage	$I_F=450A, V_{GE}=0V$ $I_F=450A, V_{GE}=0V$ $I_F=450A, V_{GE}=0V$	$T_{vj}=25^{\circ}C$ $T_{vj}=125^{\circ}C$ $T_{vj}=150^{\circ}C$	$V_F$	2.40 2.60 2.64	2.90	V
反向恢复峰值电流 Peak reverse recovery current	$I_F=450A$ $-di_F/dt=3126A/\mu s(T_{vj}=150^{\circ}C)$ $V_R=900V, V_{GE}=-15V$	$T_{vj}=25^{\circ}C$ $T_{vj}=125^{\circ}C$ $T_{vj}=150^{\circ}C$	$I_{RM}$	190 223 214		A
恢复电荷 Recovered charge	$I_F=450A$ $-di_F/dt=3126A/\mu s(T_{vj}=150^{\circ}C)$ $V_R=900V, V_{GE}=-15V$	$T_{vj}=25^{\circ}C$ $T_{vj}=125^{\circ}C$ $T_{vj}=150^{\circ}C$	$Q_r$	60.30 83.50 94.40		$\mu C$
反向恢复损耗（每脉冲） Reverse recovered energy	$I_F=450A$ $-di_F/dt=3126A/\mu s(T_{vj}=150^{\circ}C)$ $V_R=900V, V_{GE}=-15V$	$T_{vj}=25^{\circ}C$ $T_{vj}=125^{\circ}C$ $T_{vj}=150^{\circ}C$	$E_{rec}$	33.20 47.60 52.30		mJ
结-外壳热阻 Thermal resistance, junction to case	每个二极管 / per diode		$R_{thJC}$		0.10	K/W
在开关状态下温度 Temperature under switching conditions			$T_{vj op}$	-40	150	$^{\circ}C$

## 负温度系数热敏电阻 / NTC-Thermistor

### 特征值 / Characteristic Values

Parameter	Conditions	Symbol	Value			Unit
			Min.	Typ.	Max.	
额定电阻值 Rated resistances	$T_c=25^{\circ}C, \pm 5\%$	$R_{25}$		5.0		K $\Omega$
B-值 B-value	$\pm 2\%$	$B_{25/50}$		3375		K

## 模块 / Module

Parameter	Conditions	Symbol	Value			Unit
绝缘测试电压 Isolation test voltage	RMS, f=50Hz, t=1min	$V_{ISOL}$	4000			V
内部绝缘 Internal isolation			Al <sub>2</sub> O <sub>3</sub>			
储存温度 Storage temperature		$T_{stg}$	-40		125	$^{\circ}C$
模块安装的扭矩 Mounting torque for modul mounting		M	3.0		6.0	Nm
重量 Weight		W		344		g



图 1. 典型输出特性 ( $V_{GE}=15V$ )

Figure 1. Typical output characteristics ( $V_{GE}=15V$ )

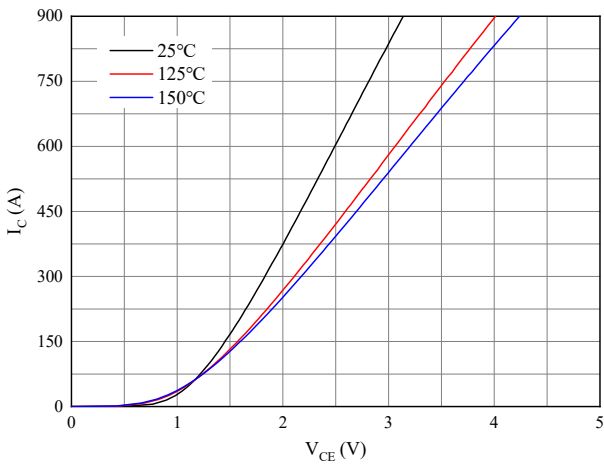

图 2. 典型输出特性 ( $T_{vj}=150^{\circ}C$ )

Figure 2. Typical output characteristics ( $T_{vj}=150^{\circ}C$ )

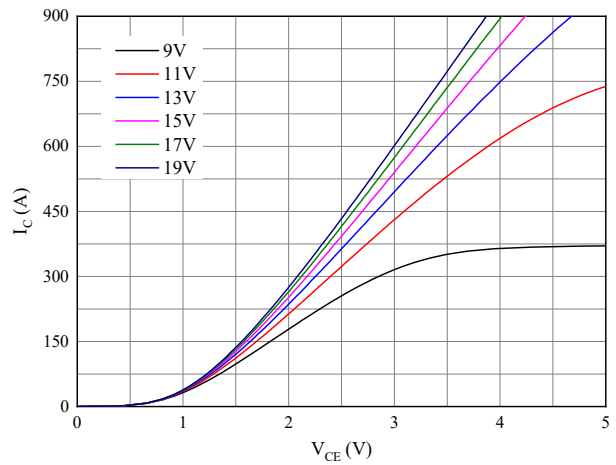

图 3. 典型传输特性 ( $V_{CE}=20V$ )

Figure 3. Typical transfer characteristic ( $V_{CE}=20V$ )

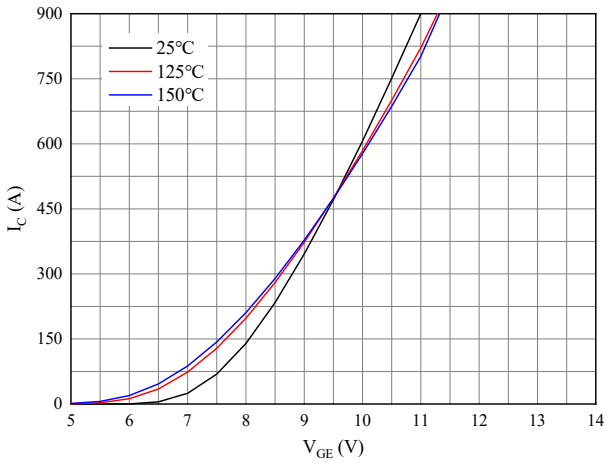

图 4. 正向偏压特性 二极管

Figure 4. Forward characteristic of Diode

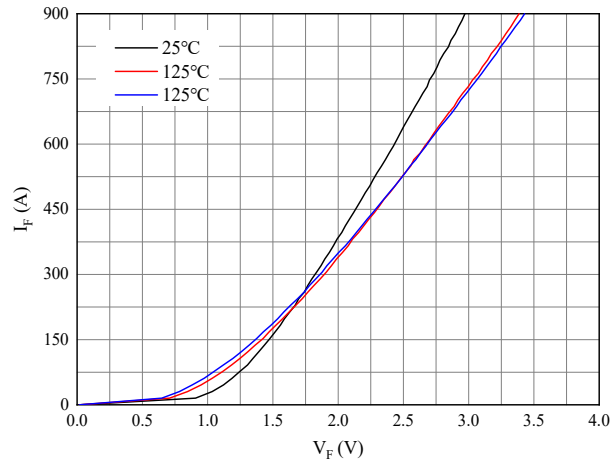

图 5. 开关损耗 逆变器

Figure 5. Switching losses of IGBT  
 $V_{GE}=\pm 15V, R_{Gon}=3.3\Omega, R_{Goff}=3.3\Omega, V_{CE}=900V$

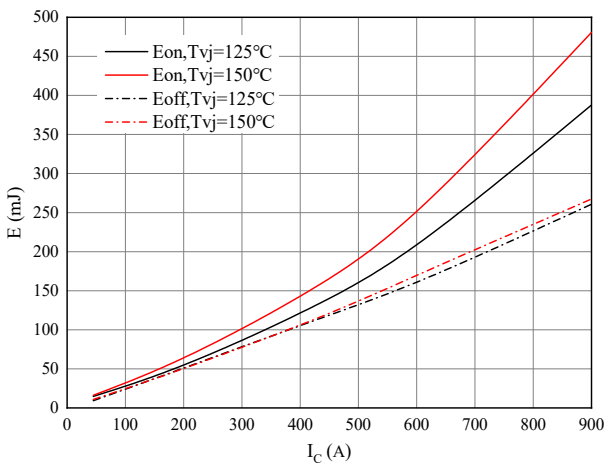

图 6. 开关损耗 逆变器

Figure 6. Switching losses of IGBT  
 $V_{GE}=\pm 15V, I_C=450A, V_{CE}=900V$

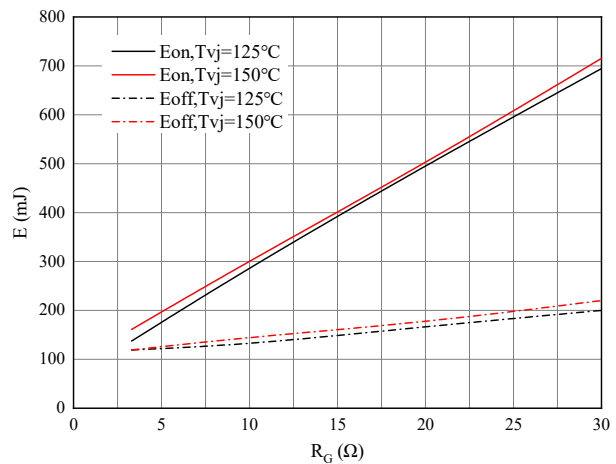

图 7. 开关损耗 二极管

Figure 7. Switching losses of Diode

$R_{Gon}=3.3 \Omega, V_{CE}=900V$

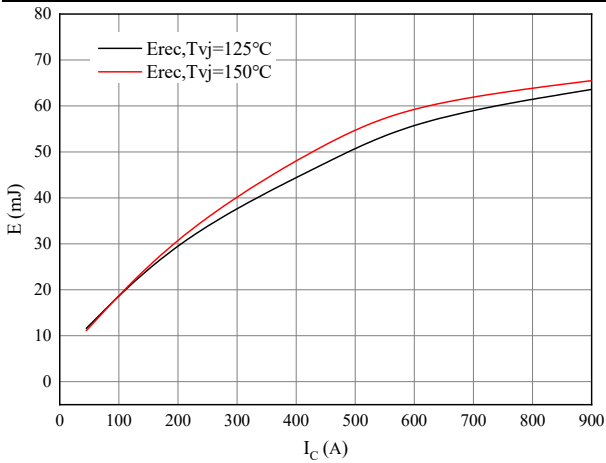

图 8. 开关损耗 二极管

Figure 8. Switching losses of Diode

$I_F=450A, V_{CE}=900V$

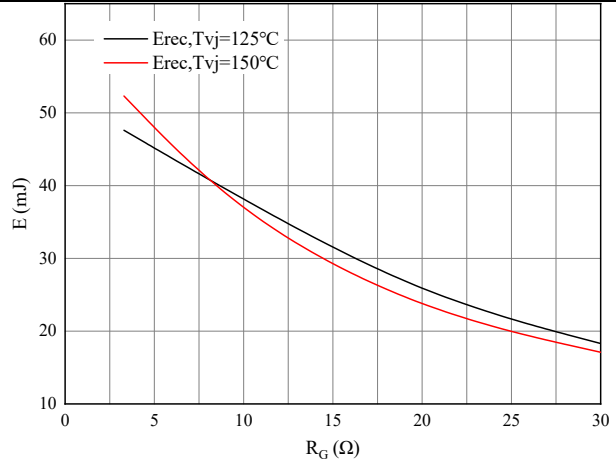

图 9. 电容特性

Figure 9. Capacitance characteristic

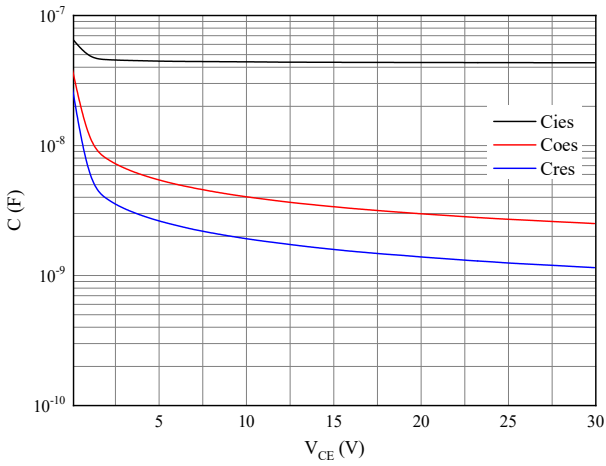

图 10. 负温系数热敏电阻 温度特性

Figure 10. NTC-Themistor-temperature characteristic

接线图 / Circuit diagram

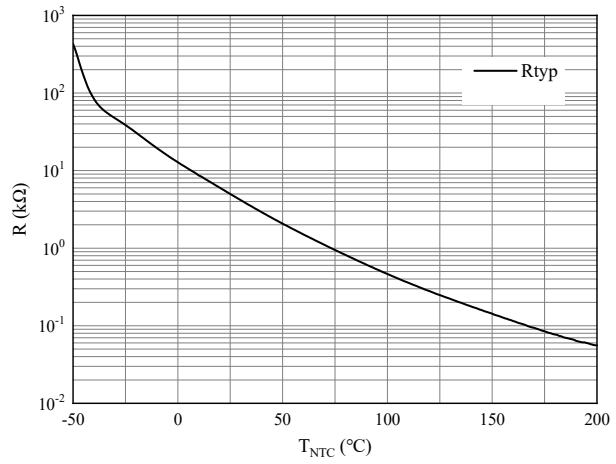
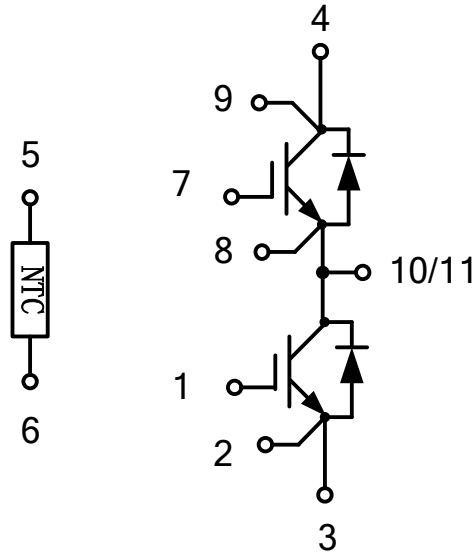

封装尺寸 / Package outlines

