

PIM IGBT Module

电气特性:

- 1200V 沟槽栅/场终止工艺
- 低开关损耗
- 正温度系数

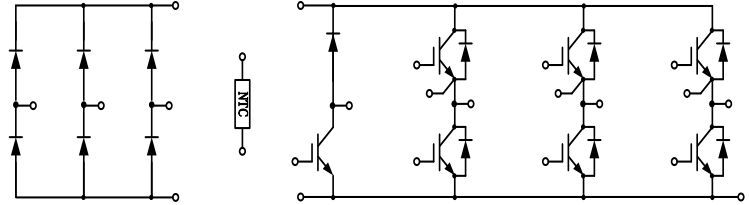

典型应用:

- 变频器
- 伺服
- 逆变器

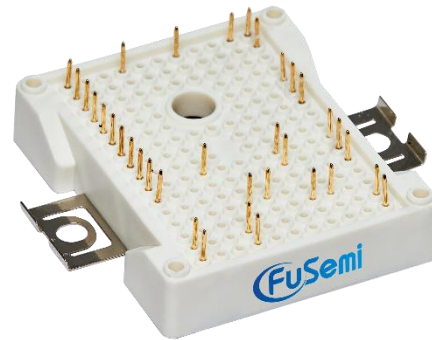

$V_{CES} = 1200V$, $I_{C\ nom} = 25A$ / $I_{CRM} = 50A$

IGBT, 逆变器 / IGBT, Inverter

最大额定值 / Maximum Ratings

Parameter	Conditions	Symbol	Value	Unit
集电极-发射极电压 Collector-Emitter voltage	$T_{vj} = 25^{\circ}C$	V_{CES}	1200	V
连续集电极直流电流 Continuous DC collector current	$T_C = 100^{\circ}C$, $T_{vj\ max} = 175^{\circ}C$	$I_{C\ nom}$	25	A
集电极重复峰值电流 Repetitive peak collector current	$t_p = 1\ ms$	I_{CRM}	50	A
总功率损耗 Total power dissipation	$T_C = 25^{\circ}C$, $T_{vj\ max} = 175^{\circ}C$	P_{tot}	175	W
栅极-发射极电压 Gate emitter voltage		V_{GE}	± 20	V

特征值 / Characteristic Values

Parameter	Conditions	Symbol	Value			Unit
			Min.	Typ.	Max.	
集电极-发射极饱和电压 Collector-Emitter saturation voltage	$V_{GE} = 15V$, $I_C = 25A$ $T_{vj} = 25^{\circ}C$ $V_{GE} = 15V$, $I_C = 25A$ $T_{vj} = 125^{\circ}C$ $V_{GE} = 15V$, $I_C = 25A$ $T_{vj} = 150^{\circ}C$	V_{CEsat}		1.65 1.95 2.00	2.00	V

栅极-发射极阈值电压 Gate-Emitter threshold voltage	$I_C=0.8\text{mA}, V_{GE}=V_{CE}$	$T_{vj}=25^\circ\text{C}$	$V_{GE(th)}$	5.2	5.85	6.4	
内部栅极电阻 Internal gate resistor			R_{Gint}		None		Ω
输入电容 Input capacitance	$f=1\text{MHz}, V_{CE}=25\text{V}, V_{GE}=0\text{V}$	$T_{vj}=25^\circ\text{C}$	C_{ies}		1.67		nF
反向传输电容 Reverse transfer capacitance			C_{res}		0.08		
集电极-发射极截止电流 Collector-emitter cut-off current	$V_{CE}=1200\text{V}, V_{GE}=0\text{V}$	$T_{vj}=25^\circ\text{C}$	I_{CES}			1	mA
栅极-发射极漏电流 Gate-emitter leakage current	$V_{CE}=0\text{V}, V_{GE}=20\text{V}$	$T_{vj}=25^\circ\text{C}$	I_{GES}			100	nA
开通延迟时间 Turn-on delay time	$I_C=25\text{A}, V_{CE}=600\text{V}$ $V_{GE}=\pm 15\text{V}, R_G=40\Omega$ (电感负载) / (inductive load)	$T_{vj}=25^\circ\text{C}$	t_{don}		63		ns
上升时间 Rise time		$T_{vj}=125^\circ\text{C}$			58		
		$T_{vj}=150^\circ\text{C}$			54		
关断延迟时间 Turn-off delay time	$I_C=25\text{A}, V_{CE}=600\text{V}$ $V_{GE}=\pm 15\text{V}, R_G=40\Omega$ (电感负载) / (inductive load)	$T_{vj}=25^\circ\text{C}$	t_{doff}		314		
		$T_{vj}=125^\circ\text{C}$			351		
		$T_{vj}=150^\circ\text{C}$			362		
下降时间 Fall time	$I_C=25\text{A}, V_{CE}=600\text{V}$ $V_{GE}=\pm 15\text{V}, R_G=40\Omega$ (电感负载) / (inductive load)	$T_{vj}=25^\circ\text{C}$	t_f		191		
		$T_{vj}=125^\circ\text{C}$			301		
		$T_{vj}=150^\circ\text{C}$			313		
开通损耗能量 (每脉冲) Turn-on energy loss per pulse	$I_C=25\text{A}, V_{CE}=600\text{V}$ $V_{GE}=\pm 15\text{V}, R_G=40\Omega$ (电感负载) / (inductive load)	$T_{vj}=25^\circ\text{C}$	E_{on}		2.88		mJ
关断损耗能量 (每脉冲) Turn-off energy loss per pulse		$T_{vj}=125^\circ\text{C}$			4.44		
		$T_{vj}=150^\circ\text{C}$			4.74		
短路数据 SC data	$V_{GE}\leq 15\text{V}, V_{cc}=800\text{V}$		I_{sc}		117		A
	$V_{CEmax}=V_{CES}-L_{sCE}\cdot di/dt \quad t_p\leq 8\mu\text{s}, T_{vj}=150^\circ\text{C}$						
结-外壳热阻 Thermal resistance, junction to case	每个 IGBT / per IGBT		R_{thJC}			0.85	K/W
在开关状态下温度 Temperature under switching conditions			$T_{vj op}$	-40		150	$^\circ\text{C}$

二极管，逆变器 / Diode, Inverter

最大额定值 / Maximum Ratings

Parameter	Conditions	Symbol	Value	Unit
反向重复峰值电压 Repetitive peak reverse voltage	$T_{vj}=25^\circ\text{C}$	V_{RRM}	1200	V
连续正向直流电流 Continuous DC forward current		I_F	25	A
正向重复峰值电流 Repetitive peak forward current	$t_p=1\text{ms}$	I_{FRM}	50	A

I ² t 值 I ² t-value	t _p =10ms, sin180°, T _j =125°C	I ² t	500	A ² s
--	--	------------------	-----	------------------

特征值 / Characteristic Values

Parameter	Conditions	Symbol	Value			Unit
			Min.	Typ.	Max.	
正向电压 Forward voltage	I _F =25A, V _{GE} =0V I _F =25A, V _{GE} =0V I _F =25A, V _{GE} =0V	T _{vj} =25°C T _{vj} =125°C T _{vj} =150°C	V _F	1.77 1.48 1.41	2.3	V
反向恢复峰值电流 Peak reverse recovery current	I _F =25A, -di _F /dt=333A/μs(T _{vj} =150°C) V _R =600V, V _{GE} =-15V	T _{vj} =25°C T _{vj} =125°C T _{vj} =150°C	I _{RM}	15 24 26		A
恢复电荷 Recovered charge	I _F =25A, -di _F /dt=333A/μs(T _{vj} =150°C) V _R =600V, V _{GE} =-15V	T _{vj} =25°C T _{vj} =125°C T _{vj} =150°C	Q _r	1.97 5.28 6.32		μC
反向恢复损耗（每脉冲） Reverse recovered energy	I _F =25A, -di _F /dt=333A/μs(T _{vj} =150°C) V _R =600V, V _{GE} =-15V	T _{vj} =25°C T _{vj} =125°C T _{vj} =150°C	E _{rec}	0.64 1.75 2.12		mJ
结-外壳热阻 Thermal resistance, junction to case	每个 Diode / per diode	R _{thJC}			1.20	K/W
在开关状态下温度 Temperature under switching conditions		T _{vj op}	-40		150	°C

二极管，整流器 / Diode, Rectifier

最大额定值 / Maximum Ratings

Parameter	Conditions	Symbol	Value	Unit
反向重复峰值电压 Repetitive peak reverse voltage	T _{vj} =25°C	V _{RRM}	1600	V
反向不重复峰值电压 Non-Repetitive peak reverse voltage	T _{vj} =25°C	V _{RSM}	1800	V
最大正向平均电流 Maximum Average Forward Current		I _{F(AV)}	25	A
正向浪涌电流 Surge forward current	t _p =10ms, sin180°, T _{vj} =25°C	I _{FSM}	320	A
I ² t 值 I ² t-value	t _p =10ms, sin180°, T _{vj} =125°C	I ² t	850	A ² s

特征值 / Characteristic Values

Parameter	Conditions	Symbol	Value			Unit
			Min.	Typ.	Max.	
正向电压 Forward voltage	I _F =25A, T _{vj} =25°C	V _F			1.1	V

反向电流 Reverse current	$V_R=V_{RRM}$	$T_{vj}=25^{\circ}\text{C}$	I_R			5	μA
在开关状态下温度 Temperature under switching conditions			$T_{vj\ op}$	-40		150	$^{\circ}\text{C}$

IGBT，制动-斩波器 / IGBT, Brake-Chopper

最大额定值 / Maximum Ratings

Parameter	Conditions	Symbol	Value	Unit
集电极-发射极电压 Collector-Emitter voltage	$T_{vj}=25^{\circ}\text{C}$	V_{CES}	1200	V
连续集电极直流电流 Continuous DC collector current	$T_C=100^{\circ}\text{C}, T_{vj\ max}=175^{\circ}\text{C}$	$I_{C\ nom}$	25	A
集电极重复峰值电流 Repetitive peak collector current	$t_p=1\ \text{ms}$	I_{CRM}	50	A
总功率损耗 Total power dissipation	$T_C = 25^{\circ}\text{C}, T_{vj\ max} = 175^{\circ}\text{C}$	P_{tot}	125	W
栅极-发射极电压 Gate emitter voltage		V_{GE}	± 20	V

特征值 / Characteristic Values

Parameter	Conditions	Symbol	Value			Unit
			Min.	Typ.	Max.	
集电极-发射极饱和电压 Collector-Emitter saturation voltage	$V_{GE}=15\text{V}, I_C=25\text{A}$ $V_{GE}=15\text{V}, I_C=25\text{A}$ $V_{GE}=15\text{V}, I_C=25\text{A}$	$T_{vj}=25^{\circ}\text{C}$ $T_{vj}=125^{\circ}\text{C}$ $T_{vj}=150^{\circ}\text{C}$	V_{CEsat}	1.80 2.08 2.15	2.20	V
栅极-发射极阈值电压 Gate-Emitter threshold voltage	$I_C=1\text{mA}, V_{GE}=V_{CE}$	$T_{vj}=25^{\circ}\text{C}$	$V_{GE(th)}$	5.2	5.85	6.4
内部栅极电阻 Internal gate resistor			R_{Gint}	None		Ω
输入电容 Input capacitance	$f=1\text{MHz}, V_{CE}=25\ \text{V}, V_{GE}=0\ \text{V}$	$T_{vj}=25^{\circ}\text{C}$	C_{ies}	1.66		nF
反向传输电容 Reverse transfer capacitance			C_{res}	0.08		
集电极-发射极截止电流 Collector-emitter cut-off current	$V_{CE}=1200\text{V}, V_{GE}=0\ \text{V}$	$T_{vj}=25^{\circ}\text{C}$	I_{CES}		1	mA
栅极-发射极漏电流 Gate-emitter leakage current	$V_{CE}=0\ \text{V}, V_{GE}=20\ \text{V}$	$T_{vj}=25^{\circ}\text{C}$	I_{GES}		100	nA
开通延迟时间 Turn-on delay time	$I_C=25\text{A}, V_{CE}=600\ \text{V}$ $V_{GE}=\pm 15\ \text{V}, R_G=40\Omega$ (电感负载) / (inductive load)	$T_{vj}=25^{\circ}\text{C}$ $T_{vj}=125^{\circ}\text{C}$ $T_{vj}=150^{\circ}\text{C}$	$t_{d\ on}$	65 60 56		ns
上升时间 Rise time	$I_C=25\text{A}, V_{CE}=600\ \text{V}$ $V_{GE}=\pm 15\ \text{V}, R_G=40\Omega$ (电感负载) / (inductive load)	$T_{vj}=25^{\circ}\text{C}$ $T_{vj}=125^{\circ}\text{C}$ $T_{vj}=150^{\circ}\text{C}$	t_r	87 90 92		

关断延迟时间 Turn-off delay time	$I_C=25A, V_{CE}=600V$ $V_{GE}=\pm 15V, R_G=40\Omega$ (电感负载) / (inductive load)	$T_{vj}=25^\circ C$ $T_{vj}=125^\circ C$ $T_{vj}=150^\circ C$	$t_{d\ off}$		301 350 355		
下降时间 Fall time	$I_C=25A, V_{CE}=600V$ $V_{GE}=\pm 15V, R_G=40\Omega$ (电感负载) / (inductive load)	$T_{vj}=25^\circ C$ $T_{vj}=125^\circ C$ $T_{vj}=150^\circ C$	t_f		231 302 290		
开通损耗能量 (每脉冲) Turn-on energy loss per pulse	$I_C=25A, V_{CE}=600V$ $V_{GE}=\pm 15V, R_G=40\Omega$ (电感负载) / (inductive load)	$T_{vj}=25^\circ C$ $T_{vj}=125^\circ C$ $T_{vj}=150^\circ C$	E_{on}		2.34 2.73 2.90		mJ
关断损耗能量 (每脉冲) Turn-off energy loss per pulse	$I_C=25A, V_{CE}=600V$ $V_{GE}=\pm 15V, R_G=40\Omega$ (电感负载) / (inductive load)	$T_{vj}=25^\circ C$ $T_{vj}=125^\circ C$ $T_{vj}=150^\circ C$	E_{off}		1.66 2.16 2.30		
结-外壳热阻 Thermal resistance, junction to case	每个 IGBT / per IGBT		R_{thJC}			1.2	K/W
在开关状态下温度 Temperature under switching conditions			$T_{vj\ op}$	-40		150	$^\circ C$

二极管, 制动-斩波器 / Diode, Brake-Chopper

最大额定值 / Maximum Ratings

Parameter	Conditions	Symbol	Value	Unit
反向重复峰值电压 Repetitive peak reverse voltage	$T_{vj}=25^\circ C$	V_{RRM}	1200	V
连续正向直流电流 Continuous DC forward current		I_F	8	A
正向重复峰值电流 Repetitive peak forward current	$t_p=1ms$	I_{FRM}	16	A
I^2t 值 I^2t -value	$V_R=0V, t_p=10ms, T_{vj}=125^\circ C$	I^2t	30	A^2s

特征值 / Characteristic Values

Parameter	Conditions	Symbol	Value			Unit
			Min.	Typ.	Max.	
正向电压 Forward voltage	$I_F=8A, V_{GE}=0V$ $I_F=8A, V_{GE}=0V$ $I_F=8A, V_{GE}=0V$	$T_{vj}=25^\circ C$ $T_{vj}=125^\circ C$ $T_{vj}=150^\circ C$	V_F		2.03 1.70 1.63	2.50 V
反向恢复峰值电流 Peak reverse recovery current	$I_F=8A,$ $-di_f/dt=217A/\mu s(T_{vj}=150^\circ C)$ $V_R=600V, V_{GE}=-15V$	$T_{vj}=25^\circ C$ $T_{vj}=125^\circ C$ $T_{vj}=150^\circ C$	I_{RM}		8 10 11	A
恢复电荷 Recovered charge	$I_F=8A,$ $-di_f/dt=217A/\mu s(T_{vj}=150^\circ C)$ $V_R=600V, V_{GE}=-15V$	$T_{vj}=25^\circ C$ $T_{vj}=125^\circ C$ $T_{vj}=150^\circ C$	Q_f		0.74 1.33 1.61	μC
反向恢复损耗 (每脉冲) Reverse recovered energy	$I_F=8A,$ $-di_f/dt=217A/\mu s(T_{vj}=150^\circ C)$ $V_R=600V, V_{GE}=-15V$	$T_{vj}=25^\circ C$ $T_{vj}=125^\circ C$ $T_{vj}=150^\circ C$	E_{rec}		0.27 0.45 0.56	mJ

结-外壳热阻 Thermal resistance, junction to case	每个 Diode / per diode	R_{thJC}			1.90	K/W
在开关状态下温度 Temperature under switching conditions		$T_{vj\ op}$	-40		150	°C

负温度系数热敏电阻 / NTC-Thermistor

特征值 / Characteristic Values

Parameter	Conditions	Symbol	Value			Unit
			Min.	Typ.	Max.	
额定电阻值 Rated resistances	$T_c=25^\circ\text{C}$, $\pm 5\%$	R_{25}		5.0		K Ω
B-值 B-value	$\pm 1\%$	$B_{25/50}$		3380		K

模块 / Module

Parameter	Conditions	Symbol	Value			Unit
绝缘测试电压 Isolation test voltage	RMS, $f=50\text{Hz}$, $t=1\text{min}$	V_{ISOL}	2500			V
内部绝缘 Internal isolation			Al ₂ O ₃			
储存温度 Storage temperature		T_{stg}	-40		125	°C
模块安装的扭矩 Mounting torque for modul mounting		M	3.0		6.0	Nm
重量 Weight		W		170		g



图 1. 典型输出特性 ($V_{GE}=15V$)

Figure 1. Typical output characteristics ($V_{GE}=15V$)

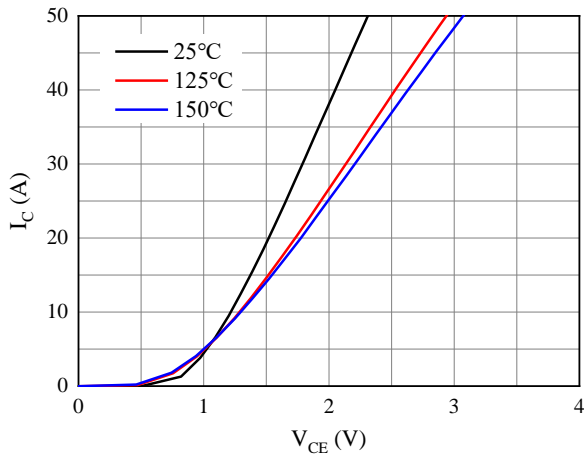

图 2. 典型输出特性 ($T_{vj}=150^{\circ}C$)

Figure 2. Typical output characteristics ($T_{vj}=150^{\circ}C$)

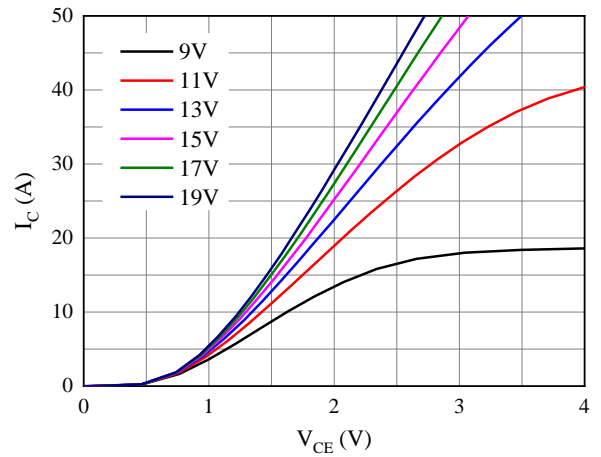
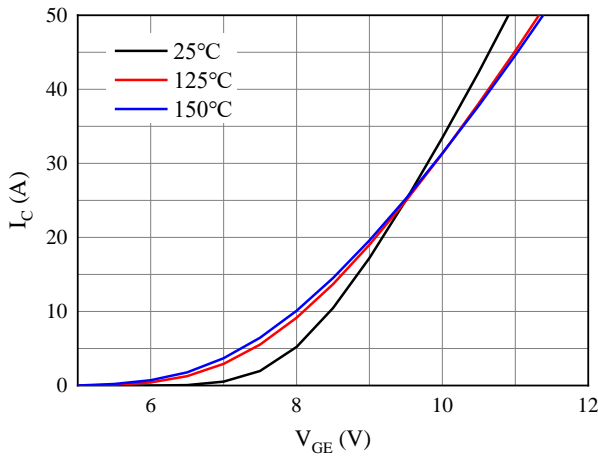

3. 典型传输特性($V_{CE}=20V$)

Figure 3. Typical transfer characteristic($V_{CE}=20V$)



图 4. 正向偏压特性 二极管

Figure 4. Forward characteristic of Diode

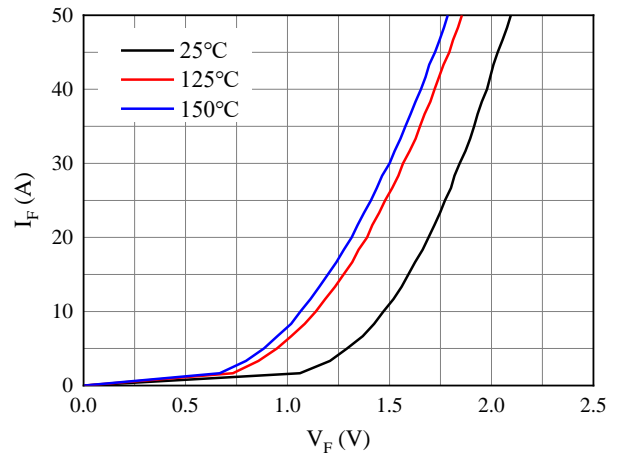

图 5. 开关损耗 逆变器

Figure 5. Switching losses of IGBT
 $V_{GE}=\pm 15V, R_{Gon}=40\Omega, R_{Goff}=40\Omega, V_{CE}=600V$

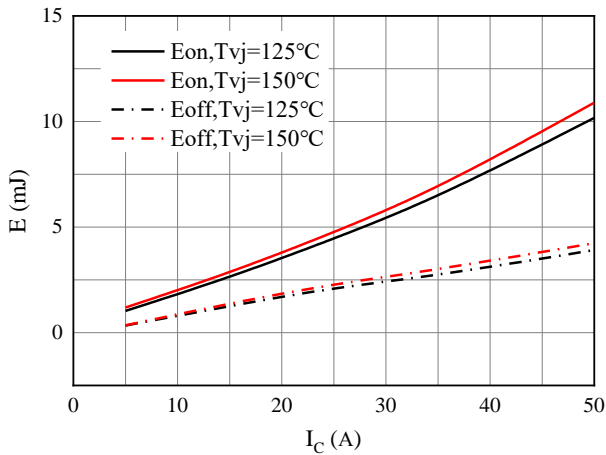

图 6. 开关损耗 逆变器

Figure 6. Switching losses of IGBT
 $V_{GE}=\pm 15V, I_C=25A, V_{CE}=600V$

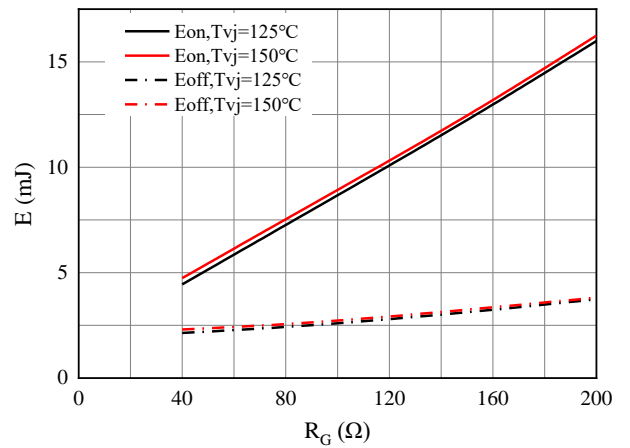

图 7. 开关损耗 二极管

Figure 7. Switching losses of Diode

$R_{Gon}=40\Omega, V_{CE}=600V$

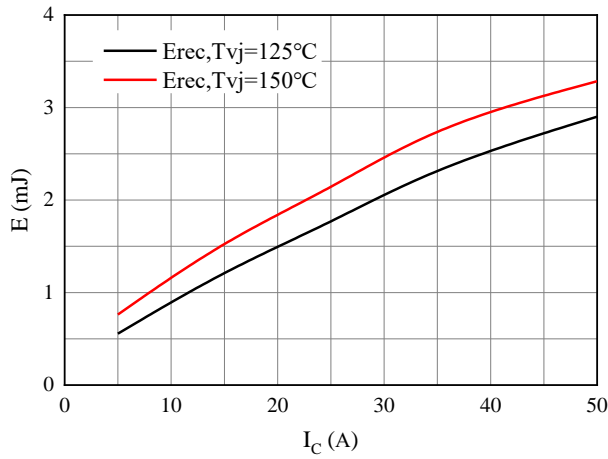

图 8. 开关损耗 二极管

Figure 8. Switching losses of Diode

$I_F=25A, V_{CE}=600V$

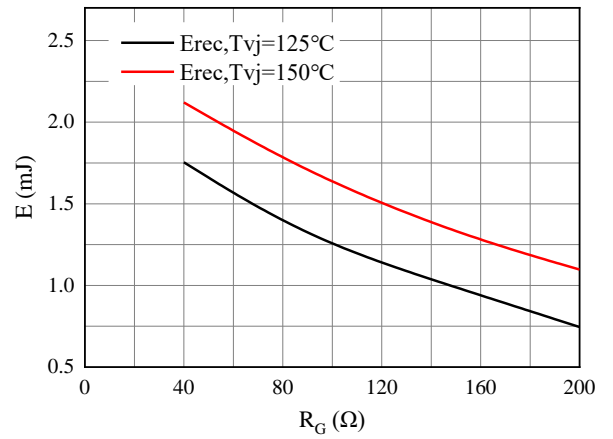

图 9. 电容特性

Figure 9. Capacitance characteristic

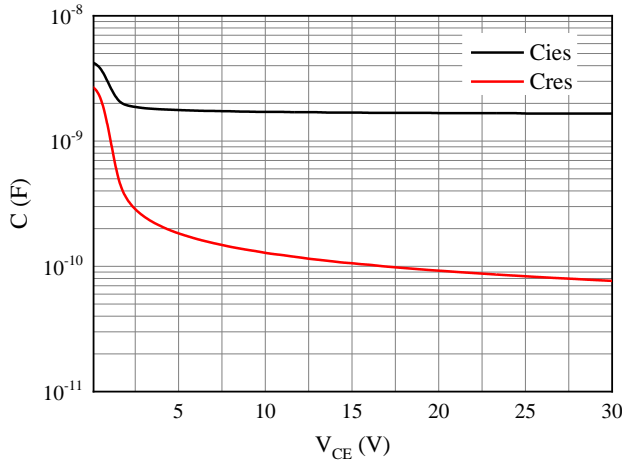

图 10. 负温系数热敏电阻 温度特性

Figure 10. NTC-Themistor-temperature characteristic

接线图 / Circuit diagram

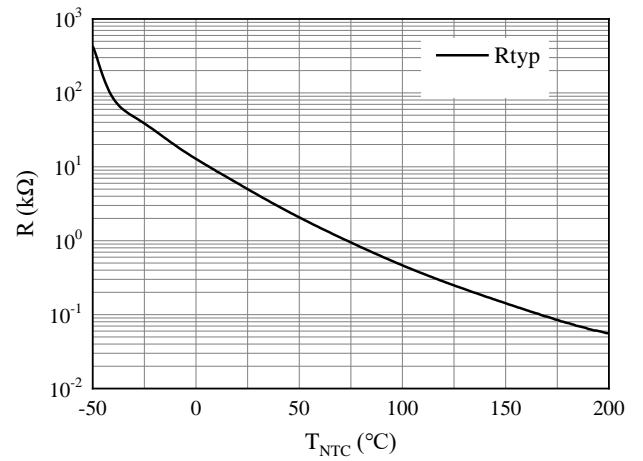
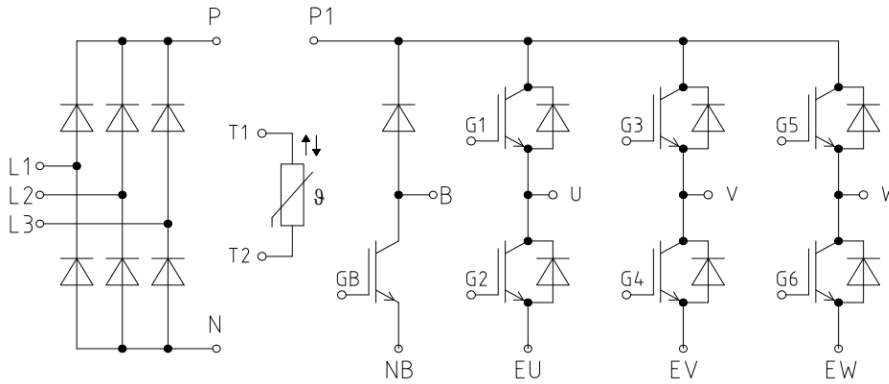

封装尺寸 / Package outlines

