

## 34mm Half Bridge IGBT Module

### 电气特性:

- 1200V 沟槽栅/场终止工艺
- 低开关损耗
- 正温度系数

### 典型应用:

- 逆变焊机
- 感应加热

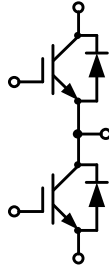

$V_{CES} = 1200V$ ,  $I_{C\ nom} = 50A$  /  $I_{CRM} = 100A$

## IGBT, 逆变器 / IGBT, Inverter

### 最大额定值 / Maximum Ratings

Parameter	Conditions	Symbol	Value	Unit
集电极-发射极电压 Collector-Emitter voltage	$T_{vj} = 25^{\circ}C$	$V_{CES}$	1200	V
连续集电极直流电流 Continuous DC collector current	$T_C = 100^{\circ}C$ , $T_{vj\ max} = 175^{\circ}C$	$I_{C\ nom}$	50	A
集电极重复峰值电流 Repetitive peak collector current	$t_p = 1\ ms$	$I_{CRM}$	100	A
总功率损耗 Total power dissipation	$T_C = 25^{\circ}C$ , $T_{vj\ max} = 175^{\circ}C$	$P_{tot}$	230	W
栅极-发射极电压 Gate emitter voltage		$V_{GE}$	$\pm 20$	V

### 特征值 / Characteristic Values

Parameter	Conditions	Symbol	Value			Unit
			Min.	Typ.	Max.	
集电极-发射极饱和电压 Collector-Emitter saturation voltage	$V_{GE} = 15V$ , $I_C = 50A$ $V_{GE} = 15V$ , $I_C = 50A$ $V_{GE} = 15V$ , $I_C = 50A$	$T_{vj} = 25^{\circ}C$ $T_{vj} = 125^{\circ}C$ $T_{vj} = 150^{\circ}C$	$V_{CESat}$	2.18 2.75 2.87	2.65	V
栅极-发射极阈值电压 Gate-Emitter threshold voltage	$I_C = 1.7mA$ , $V_{GE} = V_{CE}$	$T_{vj} = 25^{\circ}C$	$V_{GE(th)}$	5.20 5.80	6.40	
栅电荷 Gate charge	$V_{GE} = -15V \dots +15V$		$Q_G$	0.26		$\mu C$
内部栅极电阻 Internal gate resistor			$R_{Gint}$	3.12		$\Omega$
输入电容 Input capacitance	$f = 1MHz$ , $V_{CE} = 25\ V$ , $V_{GE} = 0\ V$	$T_{vj} = 25^{\circ}C$	$C_{ies}$	3.72		nF

反向传输电容 Reverse transfer capacitance		$C_{res}$		0.12		
集电极-发射极截止电流 Collector-emitter cut-off current	$V_{CE}=1200V, V_{GE}=0V$	$T_{vj}=25^{\circ}C$	$I_{CES}$		1	mA
栅极-发射极漏电流 Gate-emitter leakage current	$V_{CE}=0V, V_{GE}=20V$	$T_{vj}=25^{\circ}C$	$I_{GES}$		100	nA
开通延迟时间 Turn-on delay time	$I_C=50A, V_{CE}=600V$ $V_{GE}=\pm 15V, R_G=15\Omega$ (电感负载) / (inductive load)	$T_{vj}=25^{\circ}C$ $T_{vj}=125^{\circ}C$ $T_{vj}=150^{\circ}C$	$t_{don}$		60 64 64	ns
上升时间 Rise time	$I_C=50A, V_{CE}=600V$ $V_{GE}=\pm 15V, R_G=15\Omega$ (电感负载) / (inductive load)	$T_{vj}=25^{\circ}C$ $T_{vj}=125^{\circ}C$ $T_{vj}=150^{\circ}C$	$t_r$		36 42 45	
关断延迟时间 Turn-off delay time	$I_C=50A, V_{CE}=600V$ $V_{GE}=\pm 15V, R_G=15\Omega$ (电感负载) / (inductive load)	$T_{vj}=25^{\circ}C$ $T_{vj}=125^{\circ}C$ $T_{vj}=150^{\circ}C$	$t_{doff}$		158 181 209	
下降时间 Fall time	$I_C=50A, V_{CE}=600V$ $V_{GE}=\pm 15V, R_G=15\Omega$ (电感负载) / (inductive load)	$T_{vj}=25^{\circ}C$ $T_{vj}=125^{\circ}C$ $T_{vj}=150^{\circ}C$	$t_f$		111 129 199	
开通损耗能量 (每脉冲) Turn-on energy loss per pulse	$I_C=50A, V_{CE}=600V$ $V_{GE}=\pm 15V, R_G=15\Omega$ (电感负载) / (inductive load)	$T_{vj}=25^{\circ}C$ $T_{vj}=125^{\circ}C$ $T_{vj}=150^{\circ}C$	$E_{on}$		3.27 5.01 6.31	mJ
关断损耗能量 (每脉冲) Turn-off energy loss per pulse	$I_C=50A, V_{CE}=600V$ $V_{GE}=\pm 15V, R_G=15\Omega$ (电感负载) / (inductive load)	$T_{vj}=25^{\circ}C$ $T_{vj}=125^{\circ}C$ $T_{vj}=150^{\circ}C$	$E_{off}$		1.91 2.36 2.72	
短路数据 SC data	$V_{GE}\leq 15V, V_{CC}=800V$ $V_{CEmax}=V_{CES}-L_{sCE}\cdot di/dt \quad t_p\leq 10\mu s, T_{vj}=150^{\circ}C$		$I_{SC}$		164	A
结-外壳热阻 Thermal resistance, junction to case	每个 IGBT / per IGBT		$R_{thJC}$		0.65	K/W
在开关状态下温度 Temperature under switching conditions			$T_{vj op}$	-40	150	$^{\circ}C$

## 二极管, 逆变器 / Diode, Inverter

### 最大额定值 / Maximum Ratings

Parameter	Conditions	Symbol	Value	Unit
反向重复峰值电压 Repetitive peak reverse voltage	$T_{vj}=25^{\circ}C$	$V_{RRM}$	1200	V
连续正向直流电流 Continuous DC forward current		$I_F$	50	A
正向重复峰值电流 Repetitive peak forward current	$t_p=1ms$	$I_{FRM}$	100	A
$I^2t$ 值 $I^2t$ -value	$t_p=10ms, \sin 180^{\circ}, T_{vj}=125^{\circ}C$	$I^2t$	613	$A^2s$

### 特征值 / Characteristic Values

Edited by Semi-Future Technologies, Edition 1.2

Publication: 2021-10-16

Parameter	Conditions	Symbol	Value			Unit
			Min.	Typ.	Max.	
正向电压 Forward voltage	$I_F=50A, V_{GE}=0V$ $I_F=50A, V_{GE}=0V$ $I_F=50A, V_{GE}=0V$	$T_{vj}=25^{\circ}C$ $T_{vj}=125^{\circ}C$ $T_{vj}=150^{\circ}C$	$V_F$	2.20 1.74 1.65	2.70	V
反向恢复峰值电流 Peak reverse recovery current	$I_F=50A,$ $-di_F/dt=1226A/\mu s(T_{vj}=150^{\circ}C)$ $V_R=600V, V_{GE}=-15V$	$T_{vj}=25^{\circ}C$ $T_{vj}=125^{\circ}C$ $T_{vj}=150^{\circ}C$	$I_{RM}$	14 27 29		A
恢复电荷 Recovered charge	$I_F=50A,$ $-di_F/dt=1226A/\mu s(T_{vj}=150^{\circ}C)$ $V_R=600V, V_{GE}=-15V$	$T_{vj}=25^{\circ}C$ $T_{vj}=125^{\circ}C$ $T_{vj}=150^{\circ}C$	$Q_r$	1.91 5.51 6.60		$\mu C$
反向恢复损耗（每脉冲） Reverse recovered energy	$I_F=50A,$ $-di_F/dt=1226A/\mu s(T_{vj}=150^{\circ}C)$ $V_R=600V, V_{GE}=-15V$	$T_{vj}=25^{\circ}C$ $T_{vj}=125^{\circ}C$ $T_{vj}=150^{\circ}C$	$E_{rec}$	0.61 1.64 1.96		mJ
结-外壳热阻 Thermal resistance, junction to case	每个二极管 / per diode		$R_{thJC}$		1.05	K/W
在开关状态下温度 Temperature under switching conditions			$T_{vj op}$	-40	150	$^{\circ}C$

## 模块 / Module

Parameter	Conditions	Symbol	Value			Unit
绝缘测试电压 Isolation test voltage	RMS, $f=50Hz, t=1min$	$V_{ISOL}$	2500			V
内部绝缘 Internal isolation			Al <sub>2</sub> O <sub>3</sub>			
储存温度 Storage temperature		$T_{stg}$	-40		125	$^{\circ}C$
模块安装的扭矩 Mounting torque for modul mounting		M	3.0		6.0	Nm
重量 Weight		W		155		g



图 1. 典型输出特性 ( $V_{GE}=15V$ )

Figure 1. Typical output characteristics ( $V_{GE}=15V$ )

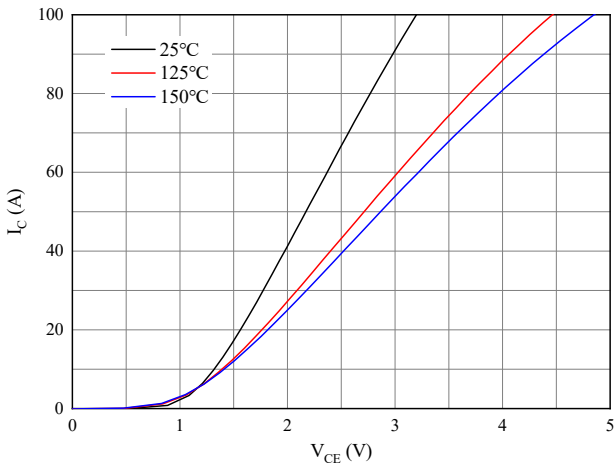

图 2. 典型输出特性 ( $T_{vj}=150^{\circ}C$ )

Figure 2. Typical output characteristics ( $T_{vj}=150^{\circ}C$ )

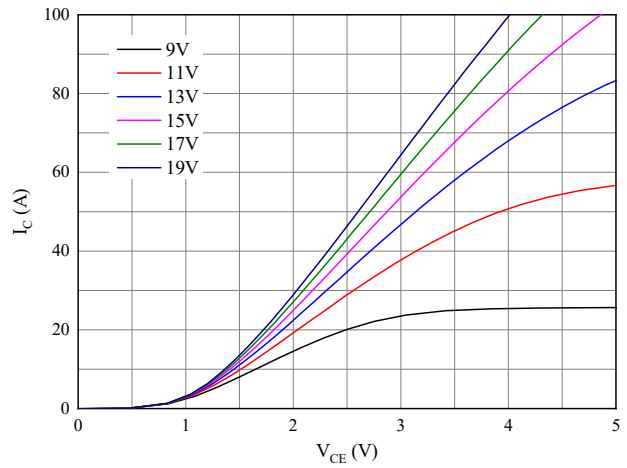

图 3. 典型传输特性 ( $V_{CE}=20V$ )

Figure 3. Typical transfer characteristic ( $V_{CE}=20V$ )

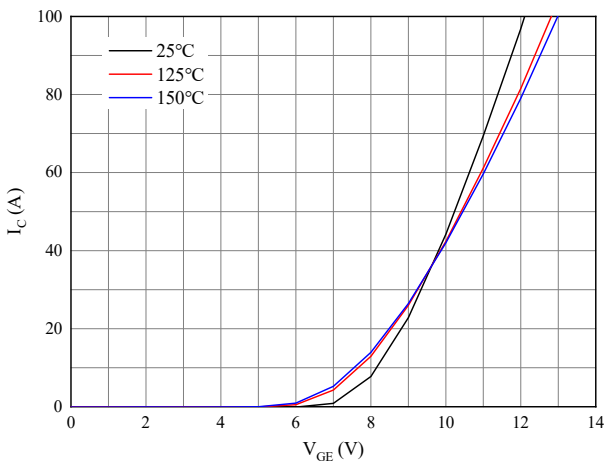

图 4. 正向偏压特性 二极管

Figure 4. Forward characteristic of Diode

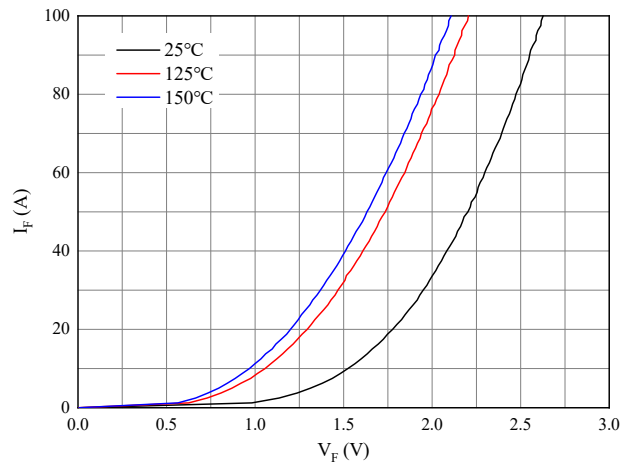

图 5. 开关损耗 逆变器

Figure 5. Switching losses of IGBT  
VGE=±15V, RGon=15Ω, RGoff=15Ω, VCE=600V

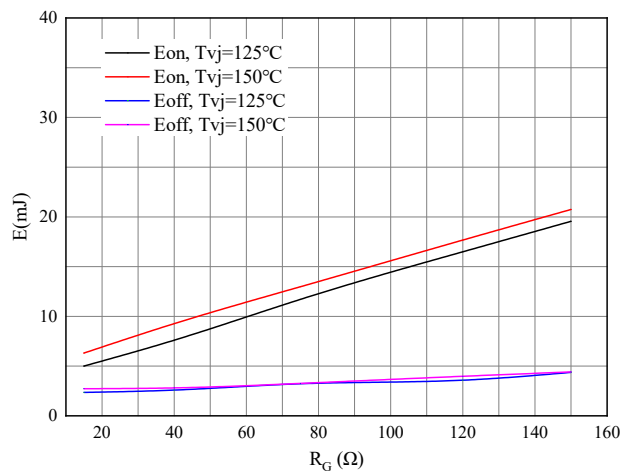
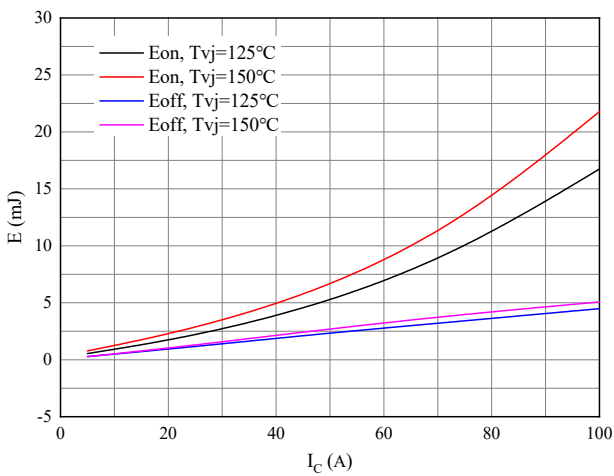

图 7. 开关损耗 二极管

Figure 7. Switching losses of Diode  
RGon=15 Ω, VCE=600V

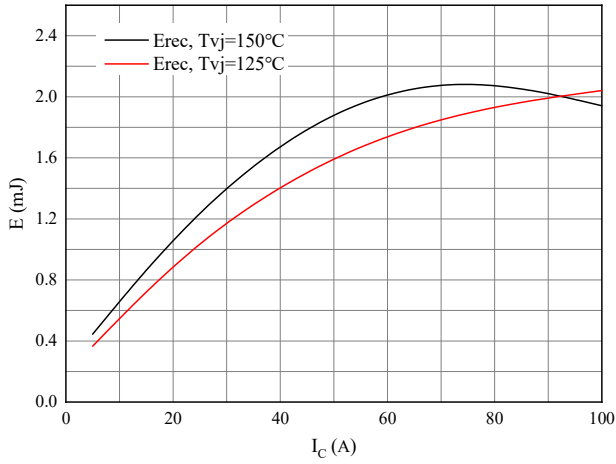

图 9. 电容特性

Figure 9. Capacitance characteristic

图 6. 开关损耗 逆变器

Figure 6. Switching losses of IGBT  
VGE=±15V, IC=50A, VCE=600V

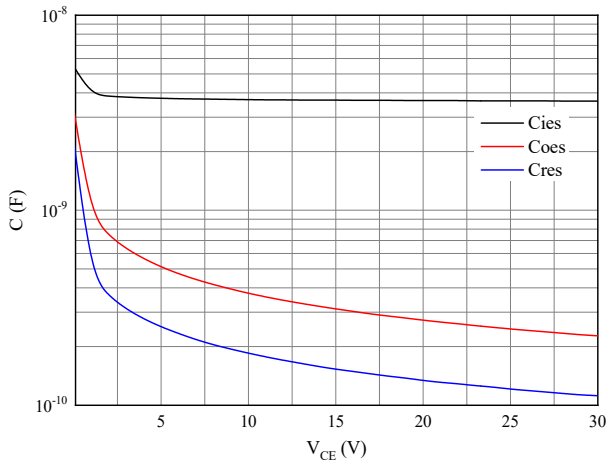

图 8. 开关损耗 二极管

Figure 8. Switching losses of Diode  
IF=50A, VCE=600V

接线图 / Circuit diagram

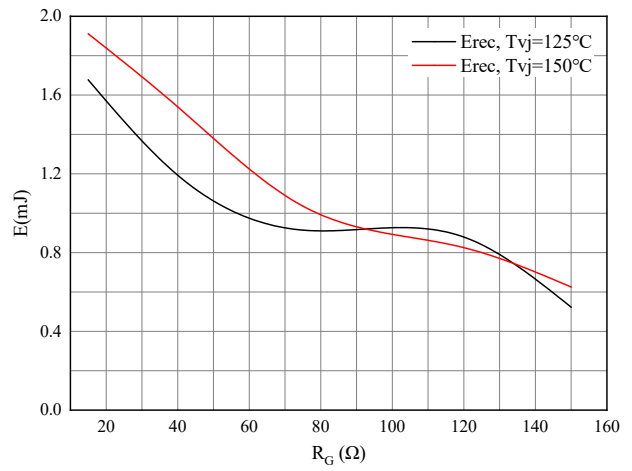
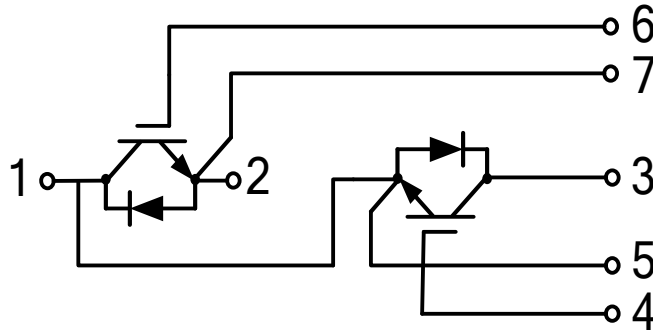

封装尺寸 / Package outlines

